

European Community Design Registration RCD 000929971

**Bin**  
**50 Litre**

**B1**

Elevation  
Design

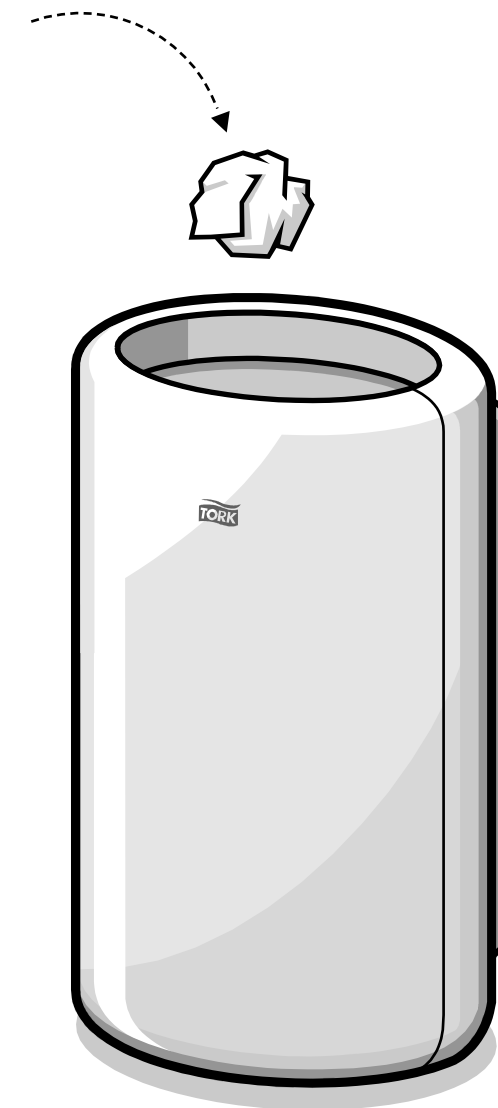

 **essity** Manufactured by Essity Hygiene and Health AB  
SE-40503 Göteborg, Sweden  
Visiting address: Mölndals Bro 2, Mölndal  
www.essity.com, www.torkglobal.com  
Made in Germany  
Patents/Brevets/Patentes: www.essity.com/patents

[www.torkglobal.com](http://www.torkglobal.com)

**TORK**

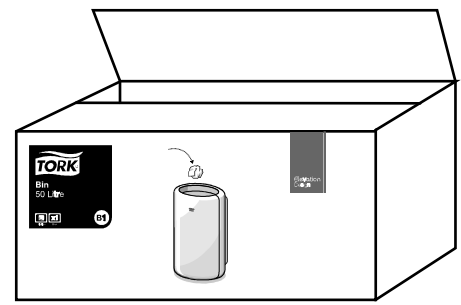

+

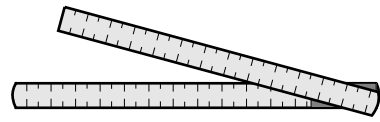
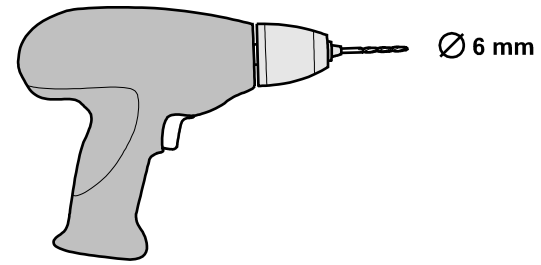
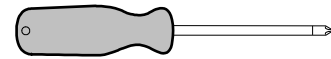
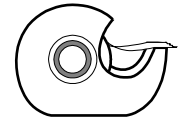

5.

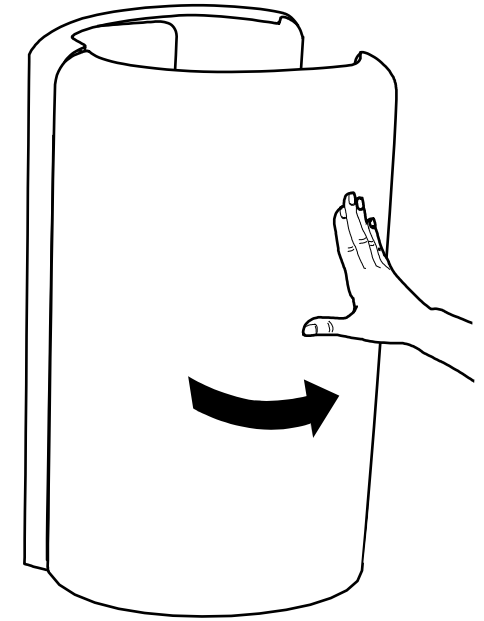

6.

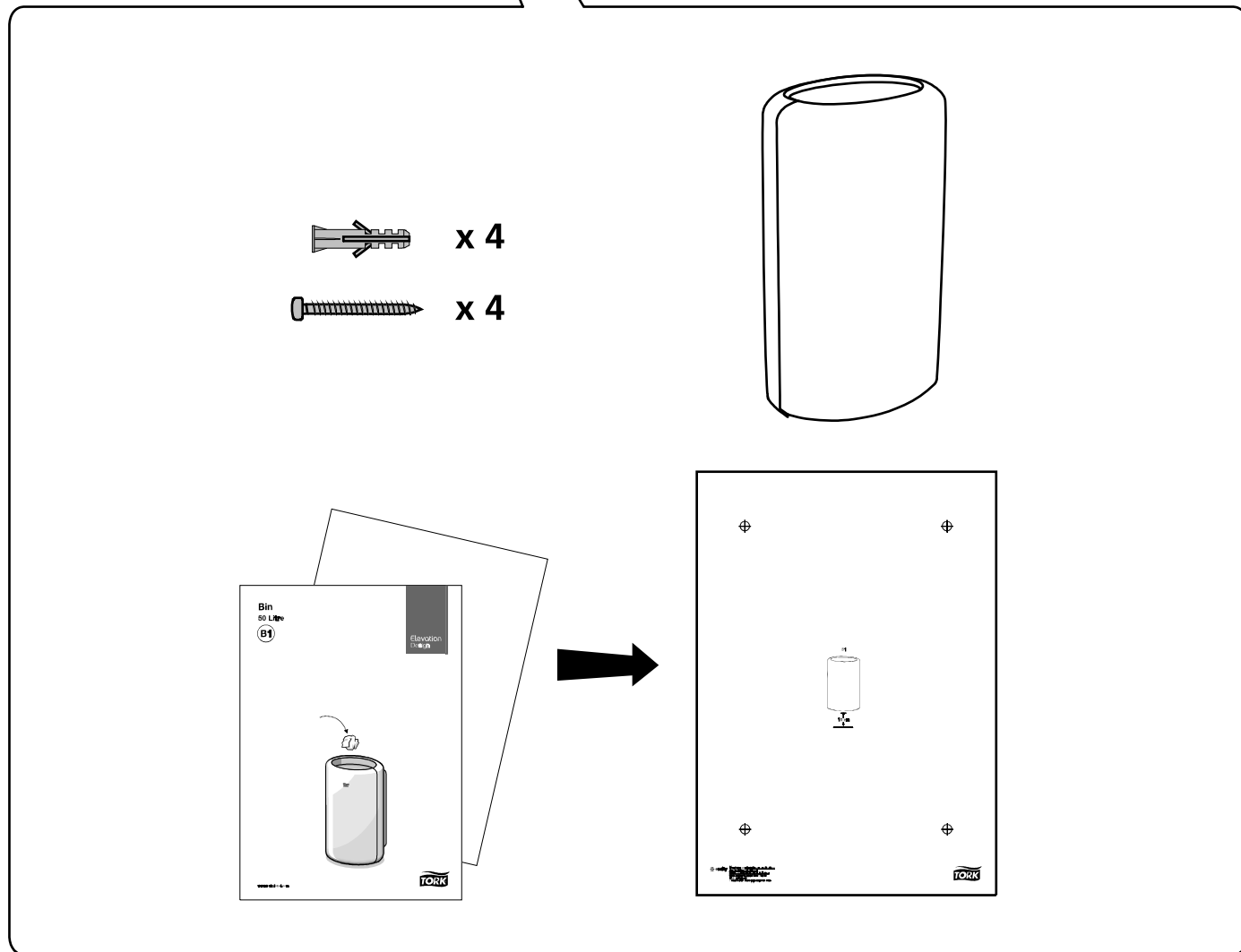
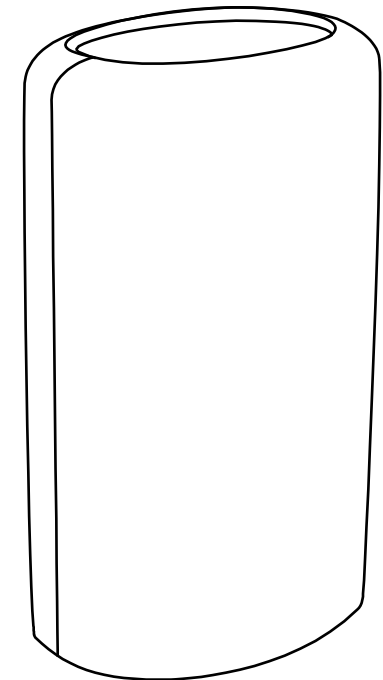

2.

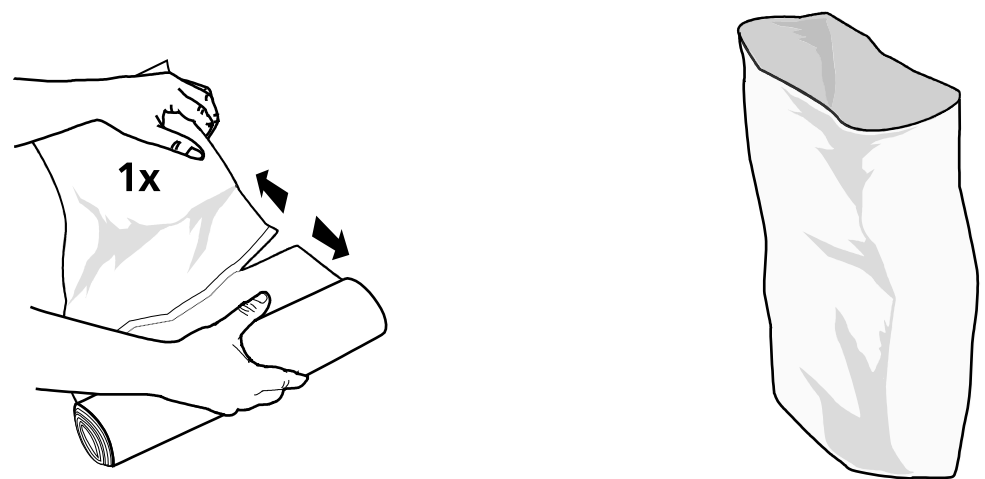

3.

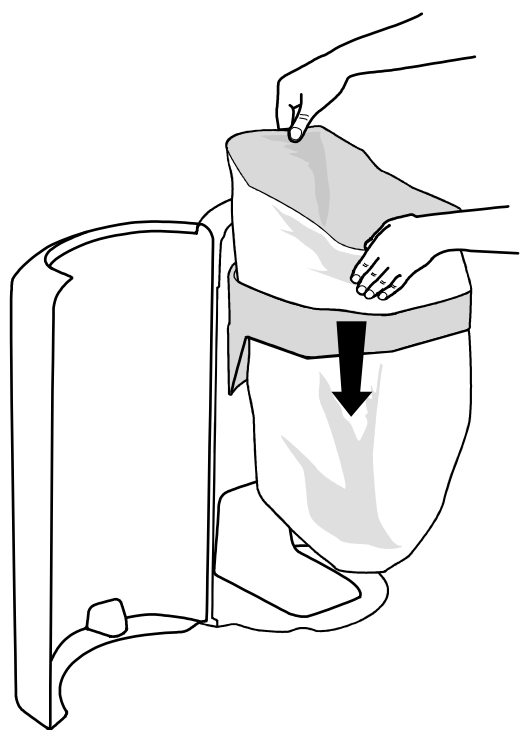

4.

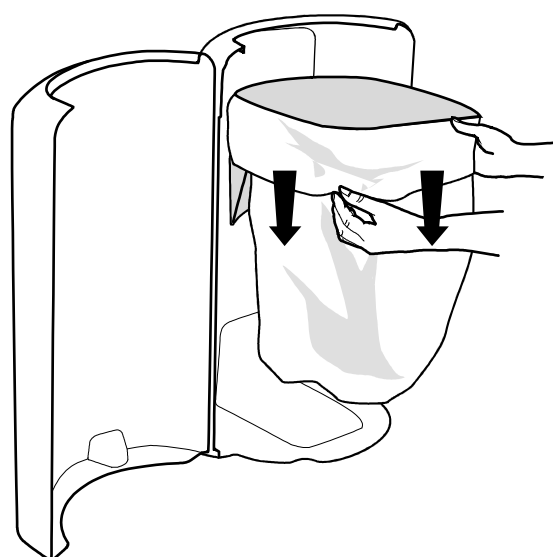

A

B

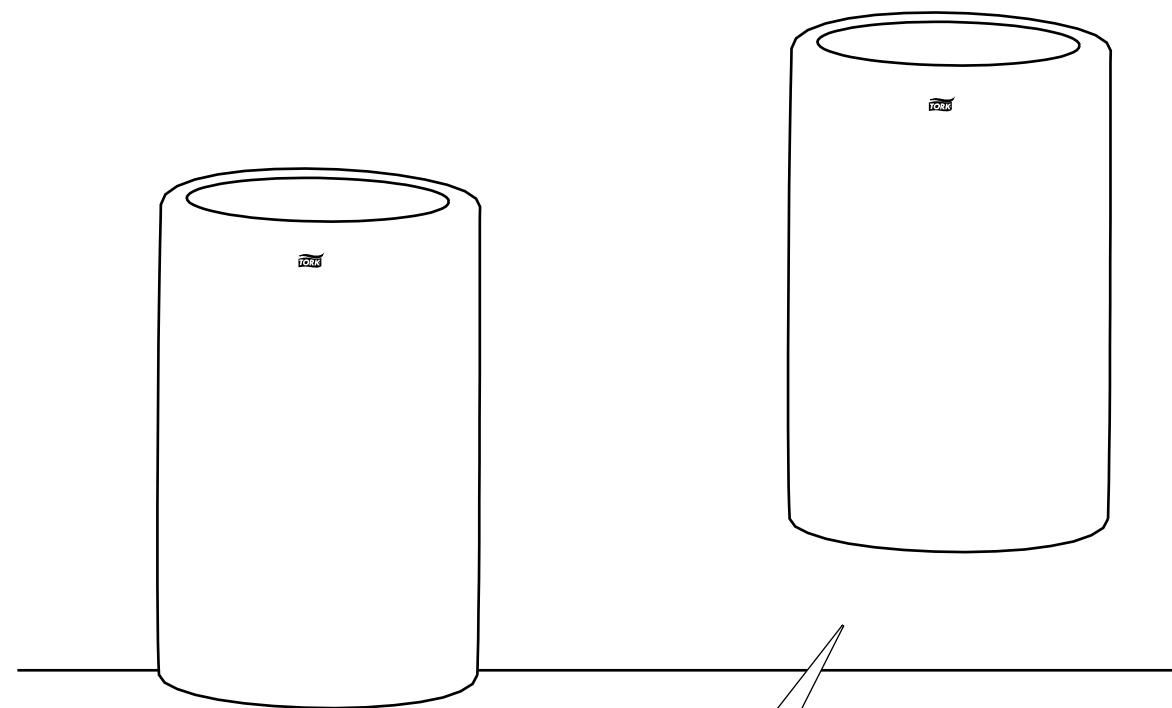

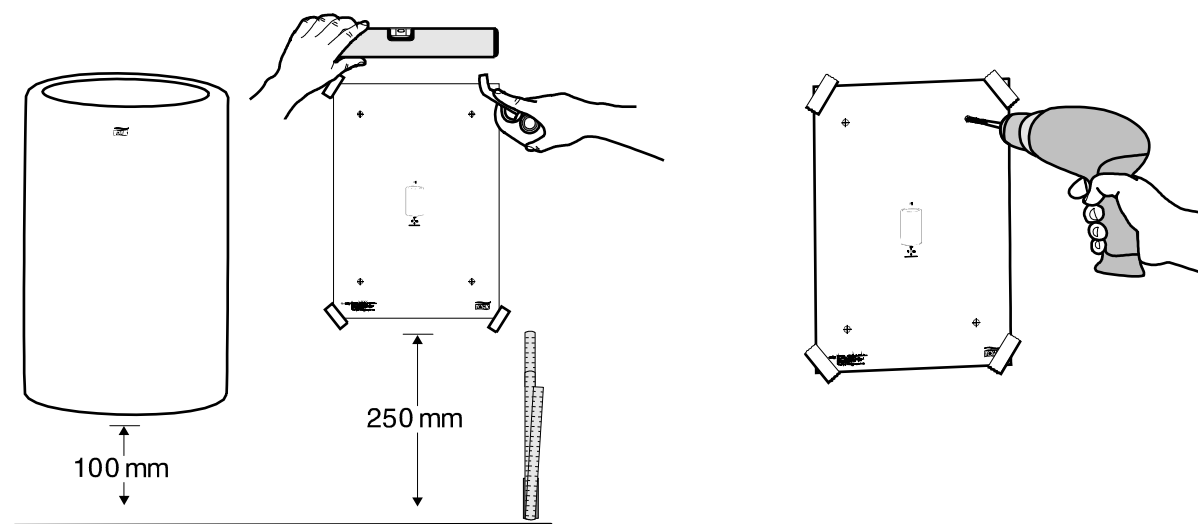

1.

2.



3.

-  x 4
-  x 4

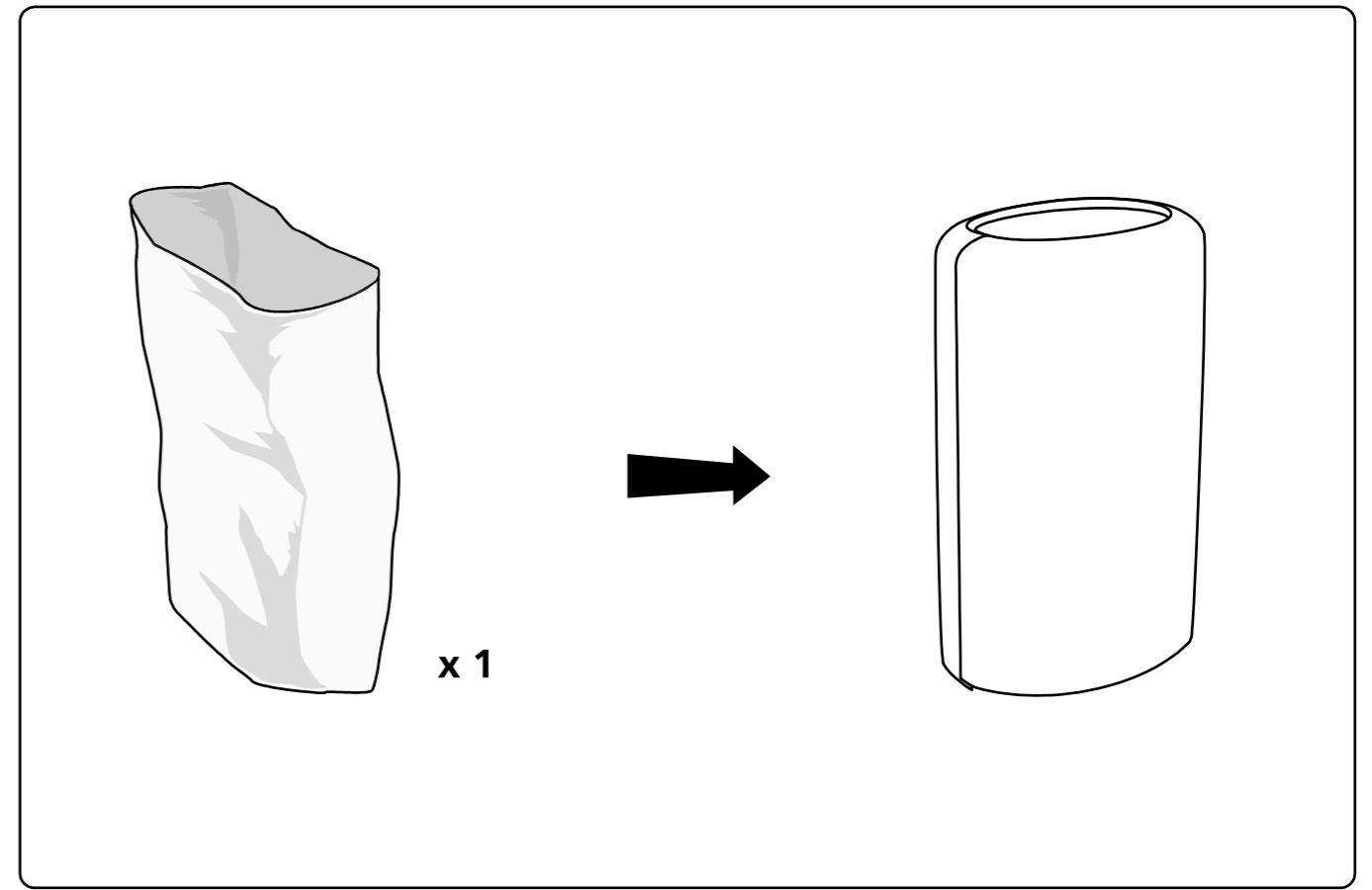
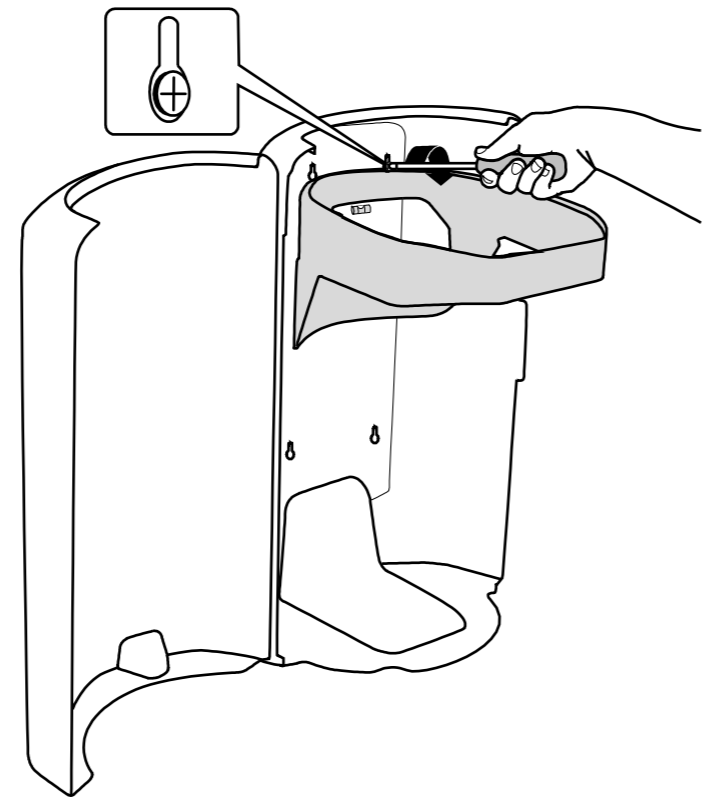

1.

4.

